



Product manual

---

## Distributed Mechanical Sensing Interrogator



# Contents

<b>1. Technical details</b>	<b>2</b>
1.1 General Information	2
1.2 System components	2
<b>2. Regulatory and certification considerations</b>	<b>2</b>
2.1 Environmental considerations	2
2.1.1 <i>Disposal of your old appliance</i>	2
2.2 Laser safety	2
2.2.1 <i>Class 1 laser</i>	2
2.2.2 <i>General precautions</i>	2
2.2.3 <i>Certification</i>	3
<b>3. Operation and maintenance</b>	<b>3</b>
3.1 Connectors	3
3.2 Setting up	3
3.2.1 <i>Power supply</i>	3
3.2.2 <i>Optical connectors</i>	3
3.2.3 <i>Ethernet connection</i>	3
3.3 Switching ON	4
3.4 Switching OFF	4
3.5 Operating the Interrogator	5
3.5.1 <i>Network properties</i>	5
3.5.2 <i>Resetting the IP Address of the Interrogator</i>	6
3.5.3 <i>Synchronisation</i>	6
3.6 Common Measuring Difficulties	7
3.6.1 <i>Dirty connector</i>	7
3.6.2 <i>Broken connector</i>	8
3.6.3 <i>Reflective fibre ending</i>	8
3.6.4 <i>Cut fibre</i>	8
3.6.5 <i>Fuse failure</i>	10

## 1. Technical details

### 1.1 General Information

The Distributed Mechanical Sensing (DMS) Interrogator with real time embedded Smart Peak Detection (SPD) is a continuous swept laser scanning Interrogator designed to interrogate Fiber Bragg Grating (FBG) based sensors in industrial environments.

DMS Interrogator includes a NIST traceable wavelength reference that provides continuous calibration to ensure system accuracy over long term operation. The high dynamic range and high output power combined with the SPD allow high resolution to be attained even for long fibre leads and lossy connections.

Multiple sensors can be connected in series in each optical fibre, in combination with eight optical channels with parallel acquisition. The DMS Interrogator is particularly suitable for large scale sensing networks acquiring a large number of sensors simultaneously and providing 1 S/s acquisition rates with sub picometer resolution.

The DMS Interrogator is available in a rack-mountable format.

### 1.2 System components

The DMS Interrogator set includes:

- Interrogator
- Power cord
- Ethernet cable (2 m)
- Connector protection caps

## 2. Regulatory and certification considerations

### 2.1 Environmental considerations

#### 2.1.1 Disposal of your old appliance

When this symbol combination (crossed-out wheeled bin and solid bar symbol) is attached to a product, it means the product is covered by the European Directive 2002/96/EC and is applicable in the European Union and other countries with separate collection systems.



All electrical and electronic products should be disposed off separately from the municipal waste stream or household via designated collection facilities appointed by the government or the local authorities. The correct disposal of your old appliance will help prevent potential negative consequences for the environment and human health. For more detailed information about disposal of your old appliance, please contact your city office or waste disposal service.

### 2.2 Laser safety

The DMS Interrogator contains a laser in its core. A laser is a light source that can be dangerous to people exposed to it. Even low power lasers can be hazardous to a person's eyesight. The coherence and low divergence of laser light means that it can be focused by the eye into an extremely small spot on the retina, resulting in localised burning and permanent damage.

The lasers are classified by wavelength and maximum output power into the several safety classes: Class 1, Class 1 M, Class 2, Class 2 M, Class 3R and Class 4.

#### 2.2.1 Class 1 laser

The DMS Interrogator is a class 1 laser product:

«Any laser or laser system containing a laser that cannot emit laser radiation at levels that are known to cause eye or skin injury during normal operation.»

It is safe under all conditions of normal use. No safety requirements are needed to use Class 1 laser devices. This product contains a laser within an enclosure that prevents exposure to the radiation and that cannot be opened without shutting down the laser.



#### 2.2.2 General precautions

Everyone who uses laser equipment should be aware of the risks.

The laser radiation is not visible to the human eye, but it can seriously damage user's eyesight.

The laser is enabled when the Interrogator is turned on.

Users should never put their eyes at the level of the horizontal plane of the optical adapters of the Interrogator or uncovered optical connectors.

Adequate eye protection should always be required if there is a significant risk for eye injury.

When an optical channel is not in use (no optical connector plugged to the Interrogator), a proper connector cap must be used. The optical connectors are subjected to maintenance and/or inspection. Please refer to section "3.6.1 Dirty connector" for maintenance procedure.

Do not attempt to open or repair a malfunctioning Interrogator. It must be returned to Synaptec Ltd for repair and calibration.

### 2.2.3 Certification

This product carries the CE marking and complies with the applicable international requirements for product safety and electromagnetic compatibility, according to the following Directives:

- Low Voltage Directive (LVD) 2014/35/EU – Electrical Safety
- Electromagnetic Compatibility (EMC) Directive 2014/30/EU

It is in compliance with the EN61326/EN55011 Emission Radiated Test Class A, under the Electromagnetic Compatibility Standard.

## 3. Operation and maintenance

### 3.1 Connectors

The connectors and buttons on Fig. 3.1 are:

1. ON/OFF Button
2. POWER and STATUS LEDs
3. Optical output connectors
4. Power connector
5. Electric fuse
6. Safety power button
7. Fans
8. Ethernet connector

**Warning**



The front panel handles highlighted in orange should not be used to lift the Interrogator, only to position the unit once its weight is fully supported.

## 3.2 Setting up

### 3.2.1 Power supply

To start the DMS Interrogator, connect the power cable to the Power Connector (number 4 in Fig. 3.1). To acknowledge proper power supply, the POWER LED will turn green during 2 seconds after connecting the power supply.

**Information**



The Interrogator must be powered using a power supply source and must not be shared with any other equipment.

### 3.2.2 Optical connectors

The DMS Interrogator can be purchased either with FC/APC, or SC/APC optical connectors. Number 3 in Fig. 3.1 exemplifies FC/APC connectors.

Attention should be paid to the cleaning of the optical connectors. A dirty connector can compromise the measurement and will degrade the Interrogator performance. It is advisable to frequently clean the connectors using appropriate tools.

DMS Interrogator has eight optical channels in parallel.

### 3.2.3 Ethernet connection

Connect the Ethernet RJ45 connector directly to a PC using an Ethernet crossover cable, or to a network connector using a direct Ethernet cable (in this case, the DMS Interrogator must be in the same subnet as your Local Network).

**Information**



The Interrogator default network configuration is "10.0.0.10:255.0.0.0:0.0.0.0".

Figure 3.1

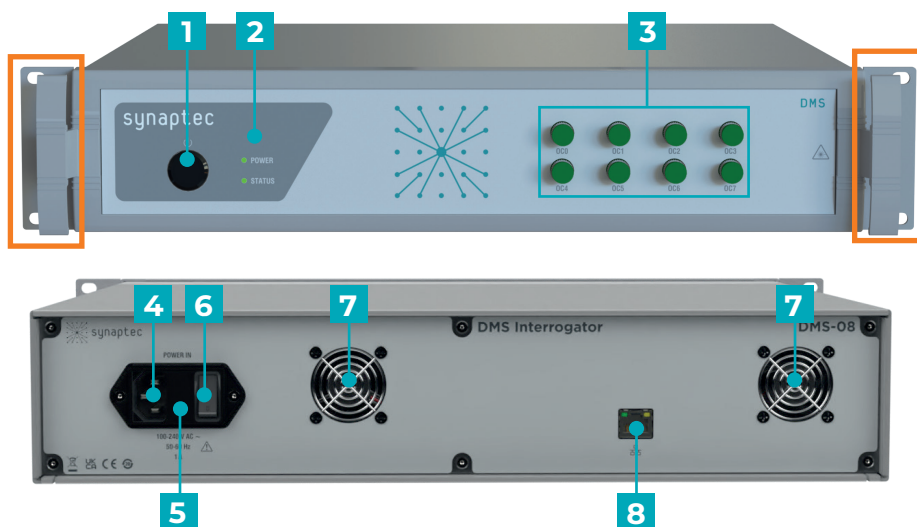

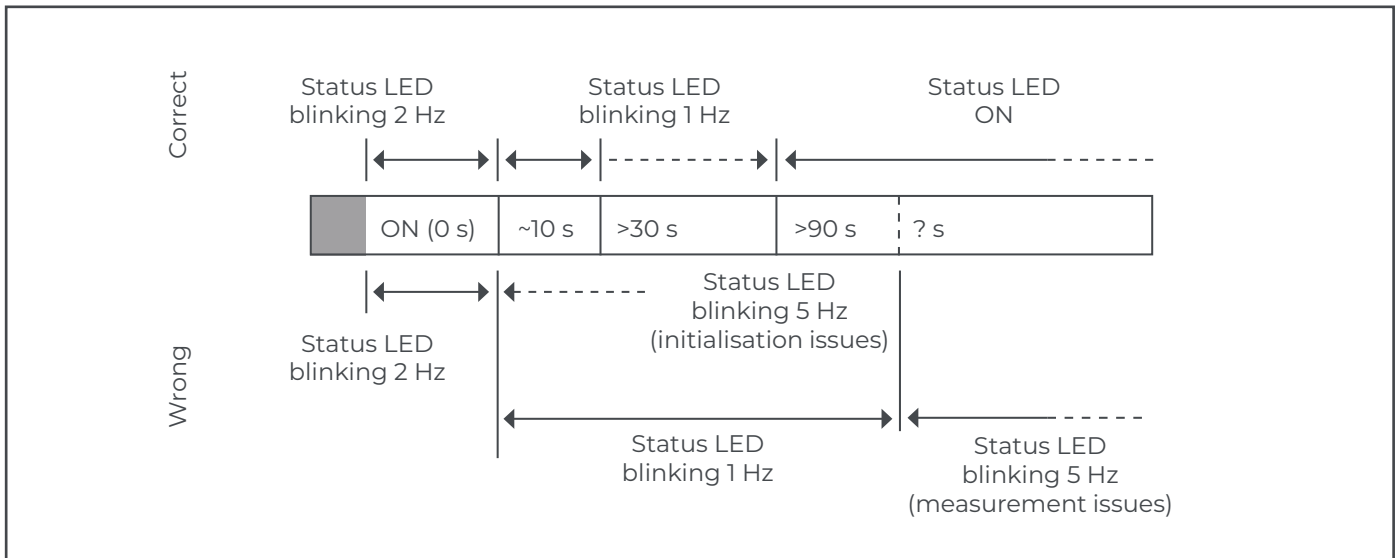

Figure 3.2

### 3.3 Switching ON

Pressing the ON/OFF button will start the Interrogator. The STATUS LED will start blinking at 2 Hz. After approximately 30 seconds it will start blinking at 1 Hz. This means that the Interrogator is already ON and responsive, but the optoelectronic module is still warming up. After approximately 90 seconds it should stay ON permanently. This means that the Interrogator is ready for operation (Fig. 3.2).

If for some reason the 6 seconds are exceeded, the user can release the button before 10 seconds are reached and the Interrogator will remain ON (Fig. 3.4).

**Information**

**i** If the Interrogator does not start correctly, the STATUS LED will blink faster. If this happens, please contact Synaptec Ltd technical support.

Figure 3.4

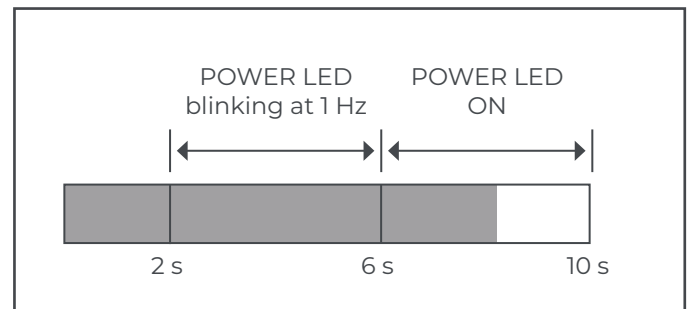

### 3.4 Switching OFF

To avoid accidental shutdown of the Interrogator, it is necessary to press the "ON/OFF" button between 2 and 6 seconds (Fig. 3.3).

**Warning**

**!** If the ON/OFF button is pressed for more than 10 seconds, irreversible changes on the Interrogator configuration will happen.

Figure 3.3

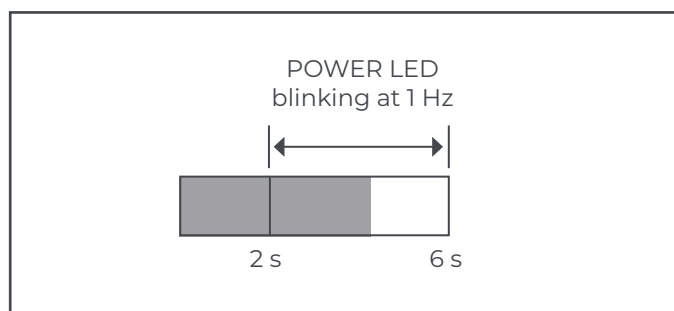

## 3.5 Operating the Interrogator

### 3.5.1 Network properties

To operate the DMS Interrogator from a personal computer, the PC network properties should be set so that both elements are configured in the same subnet.

To configure your personal computer so that it is on the same subnet as the default for the Interrogator, proceed as follows:

- On the control panel choose 'Network and Internet', and then 'Network and Sharing Centre'.
- Double click on 'Ethernet'. The window displayed in Fig. 3.5 will appear. Click on 'Properties'.
- Select the Internet Protocol (TCP/IP) and click on the button 'Properties' (Fig. 3.6).
- Set the IP address and the subnet mask as in Fig. 3.7.
- Press 'OK'.

Figure 3.5

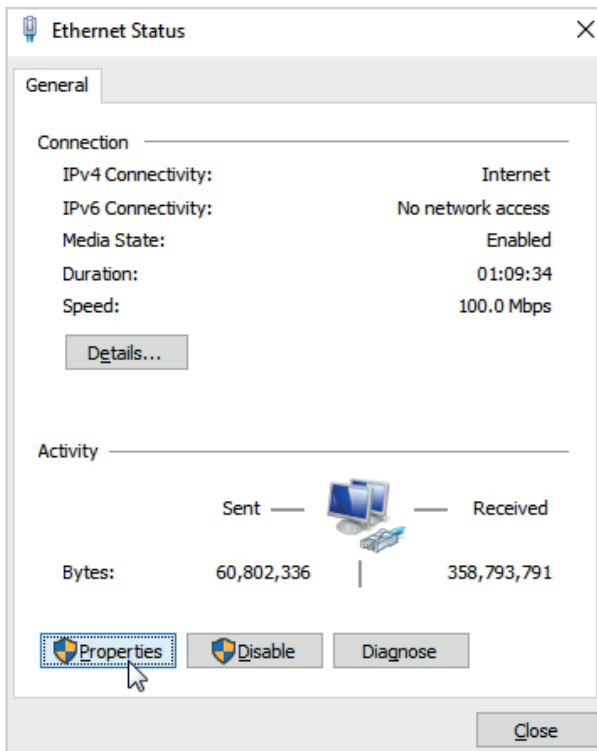

Figure 3.6

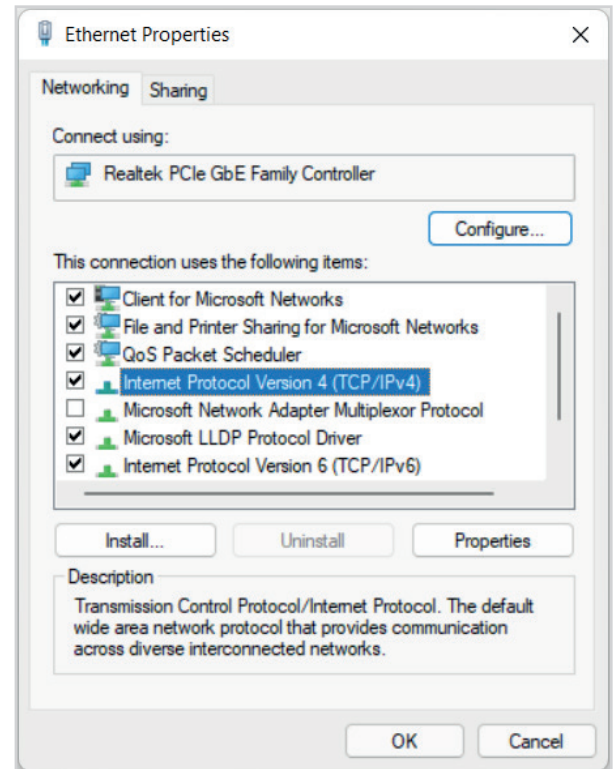
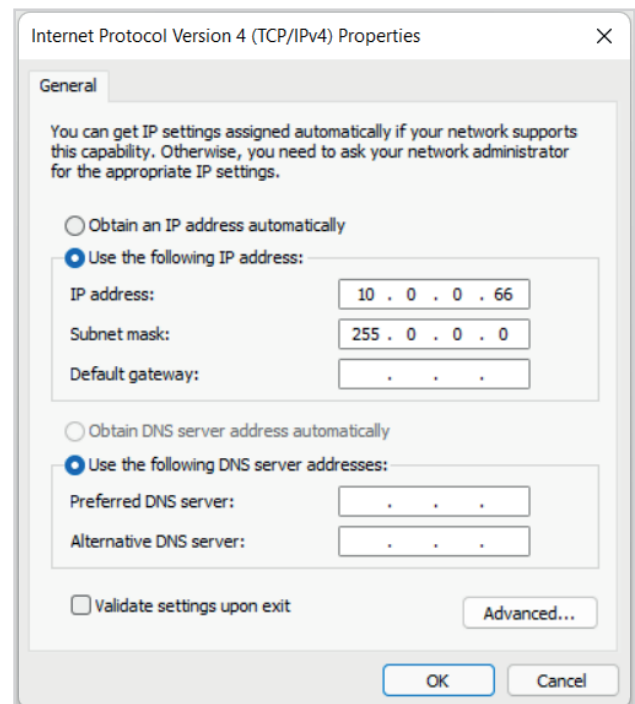

Figure 3.7



### 3.5.2 Resetting the IP Address of the Interrogator

If for any reason there is the need to physically change the IP address of the Interrogator, there is a reset procedure that consists of pressing the ON/OFF button for more than 10 seconds.

When the button is being pressed for 10 seconds the POWER LED blinks 3 times and goes OFF. At this moment the ON/OFF button can be released, and the reset of the IP address will happen.



#### Information

The Interrogator default network properties are "10.0.0.10:255.0.0.0:0.0.0.0".

### 3.5.3 Synchronisation

In order to achieve synchronous measurements between different devices, the Network Time Protocol (NTP) synchronisation via Ethernet must be used.

Each optical Interrogator can synchronise its internal clock with an NTP server. It is possible to achieve accuracies of 1 ms or higher, depending on whether or not a dedicated NTP server is being used.

Further information about NTP can be found at <http://www.ntp.org>.

#### Measuring systems typology

A measurement system can be as simple as a single Interrogator or a bit more complex with combined Interrogators with the same or different sampling rates, and Interrogators combined with other equipment.

##### Single Interrogator

For the usage of a single Interrogator no special synchronisation is needed.

##### Multiple Interrogators

If more than one Interrogator is used, synchronisation becomes important and if an NTP server is running, the equipment will start syncing as soon as a first communication from the server is received.

Figure 3.8

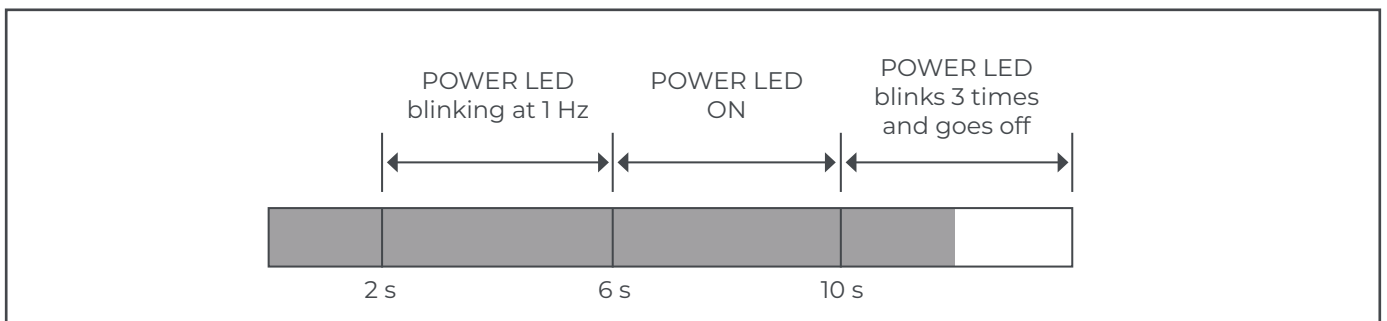
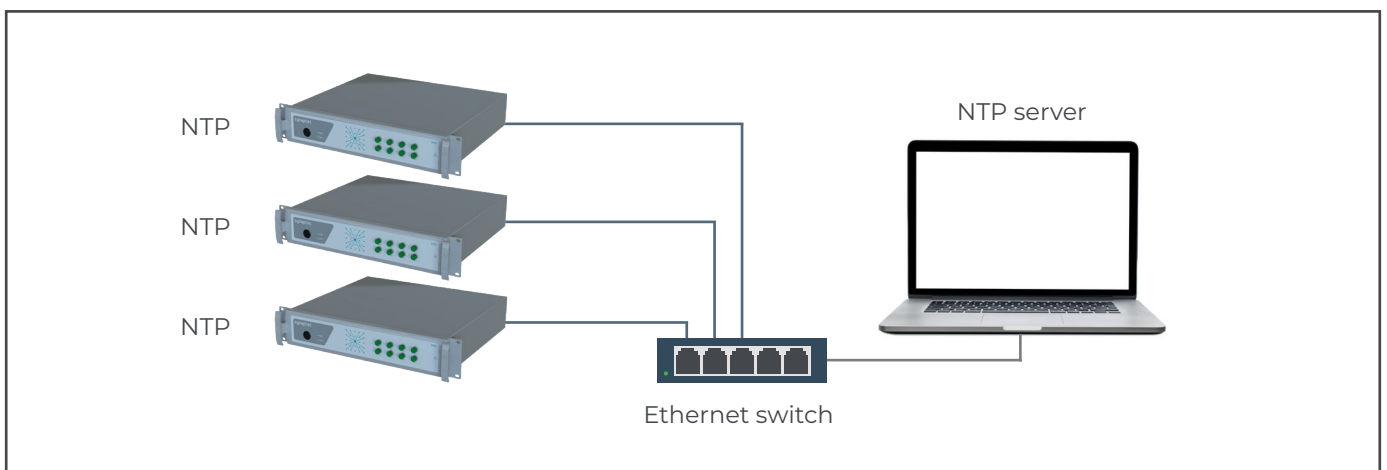

Figure 3.9





## Synchronisation process

Each Interrogator synchronises its internal clock with the NTP server. Upon starting, all devices and the NTP server need some settling time to achieve the best synchronism possible.

The following features for NTP synchronisation are available:

<b>Number of devices to be synchronised</b>	Unlimited
<b>Synchronisation accuracy</b>	10 $\mu$ s to 10 ms
<b>Synchronisation settling time</b>	Up to 30 min during first start, up to 2 min during restart
<b>Synchronisation master</b>	External SyncMaster, e.g. PC

For a good synchronisation, the dedicated NTP server should run continuously. The accuracy is described by the two values:

- **Offset:** average deviation from time server
- **Jitter:** typical variation range of the offset value

The clock synchronisation is classified using the following offset intervals:

- **<500  $\mu$ s:** excellent
- **<1 ms:** very good
- **<2 ms:** good
- **<5 ms:** acceptable
- **<10 ms:** poor
- **>10 ms:** not acceptable

A successful NTP Sync is achieved if the offset between the internal clock of the device and the NTP server is below 5 ms.

## Power outage

If a power outage happens when the DMS Interrogator is running in the ready, free acquisition or continuous acquisition states, the operational state is maintained once the power supply is re-established with the stored acquisition settings.

If the power outage occurs in the scheduled acquisition mode, the operational state is maintained once the power supply is re-established except in the case the Interrogator is in sleep mode for power saving.

## Default network properties

The default network properties are “10.0.0.10:255.0.0.0:0.0.0.0”. Whenever there is the need, the Interrogator can be reset to this default address (see section “3.5.2 Resetting the IP Address of the Interrogator” on page 6). The default address cannot be changed.



### Warning

**If the Interrogator is in sleep mode when a power outage occurs, scheduling will not resume upon power up.**

## 3.6 Common measuring difficulties

There may be the possibility of having measuring malfunctions due to several problems in the sensing network or optical connections. A list of some of the usual problems is described below with the explanation for its occurrence and correction.

### 3.6.1 Dirty connector

When an Interrogator is repeatedly being plugged in and out with optical connectors, it is very important that the connectors are cleaned prior to any connection. If not, dust and moisture can get deposited in the Interrogator adaptor and this will compromise measurements. In Fig. 3.10 a picture of a magnified connector is presented. The dark grey circle corresponds to the fibre cladding and the small light grey circle is the core of the fibre. One picture for a clean connector and one picture for a dirty connector are presented.

Figure 3.10

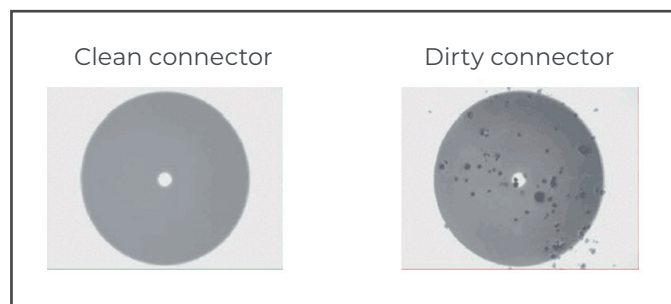

The most common effect of dirt on the connections is that there is a large amount of broad band light being reflected at the connection, at both directions, meaning that the dynamic range for measuring becomes smaller (Fig. 3.11).



Figure 3.11

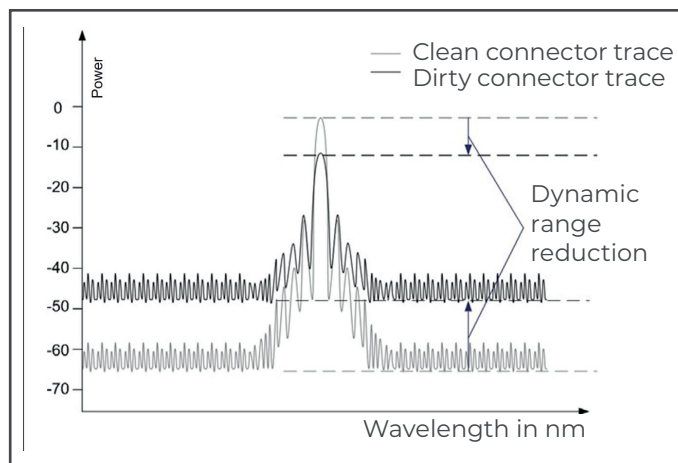

To clean an optical Interrogator adapter, use an appropriate cotton swab (there are several cleaning swabs in the market frequently used for telecom) embedded in isopropyl alcohol. Insert it in the optical adapter, as in Fig. 3.12, and rotate the swab always in the same direction.

Figure 3.12



### 3.6.2 Broken connector

It may also occur that the Interrogator adapter sleeve breaks. In this case, when an optical connector is inserted, it does not get proper alignment and measurements are compromised. A broken sleeve will look as shown in Fig. 3.13. To solve this problem you should contact Synaptec Ltd.

Figure 3.13



### 3.6.3 Reflective fibre ending

It may occur that the Interrogator does not find any sensor on an array even if connections were performed correctly. One of the reasons may be the excess of reflected light saturating the detectors.

When a fibre is perfectly cut (Fig. 3.14 on the top), a large amount of light is reflected right back to the fibre core in the right direction, heading to the Interrogator detectors. When this occurs, an index matching gel or an angled termination must be used. If these are unavailable, the tip of the fibre can be smashed with a metallic tool. This will destroy the perfect geometry (Fig. 3.14 on the bottom) and the light that is reflected at the surface will take random directions ending up outside the core.

Figure 3.14

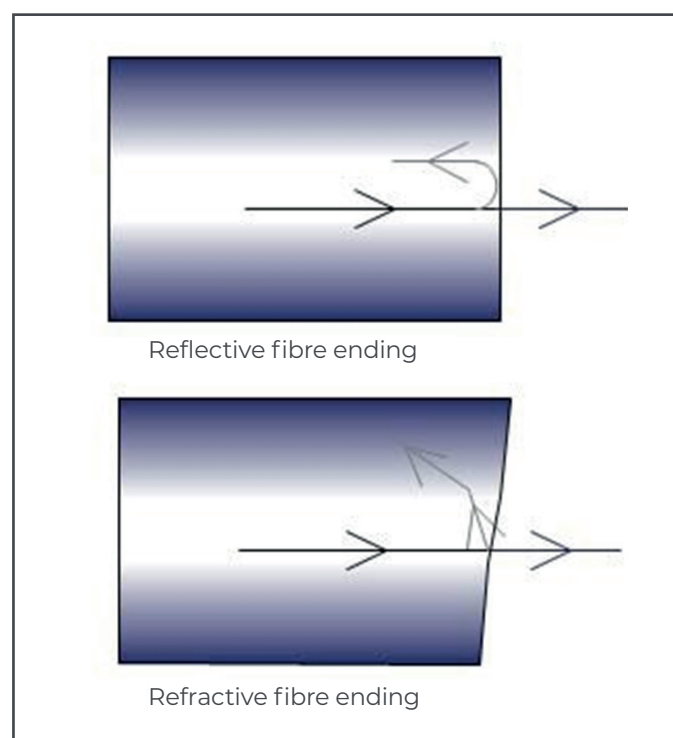

### 3.6.4 Cut fibre

When the fibre, for any reason, is broken between two sensors in a series, the sensors that are after the fault may disappear from the optical spectrum and may not be detected.

There may also be the case that the fibre is cut, but not completely spread apart (e.g., the fibre is damaged in an area covered with glue). This will cause Fabry-Pérot effect – the light will suffer multiple reflections inside the cavity creating sinusoidal background reflection. Fig. 3.16 shows a schematic representation of the reflected spectrum for these three presented cases.

Figure 3.16

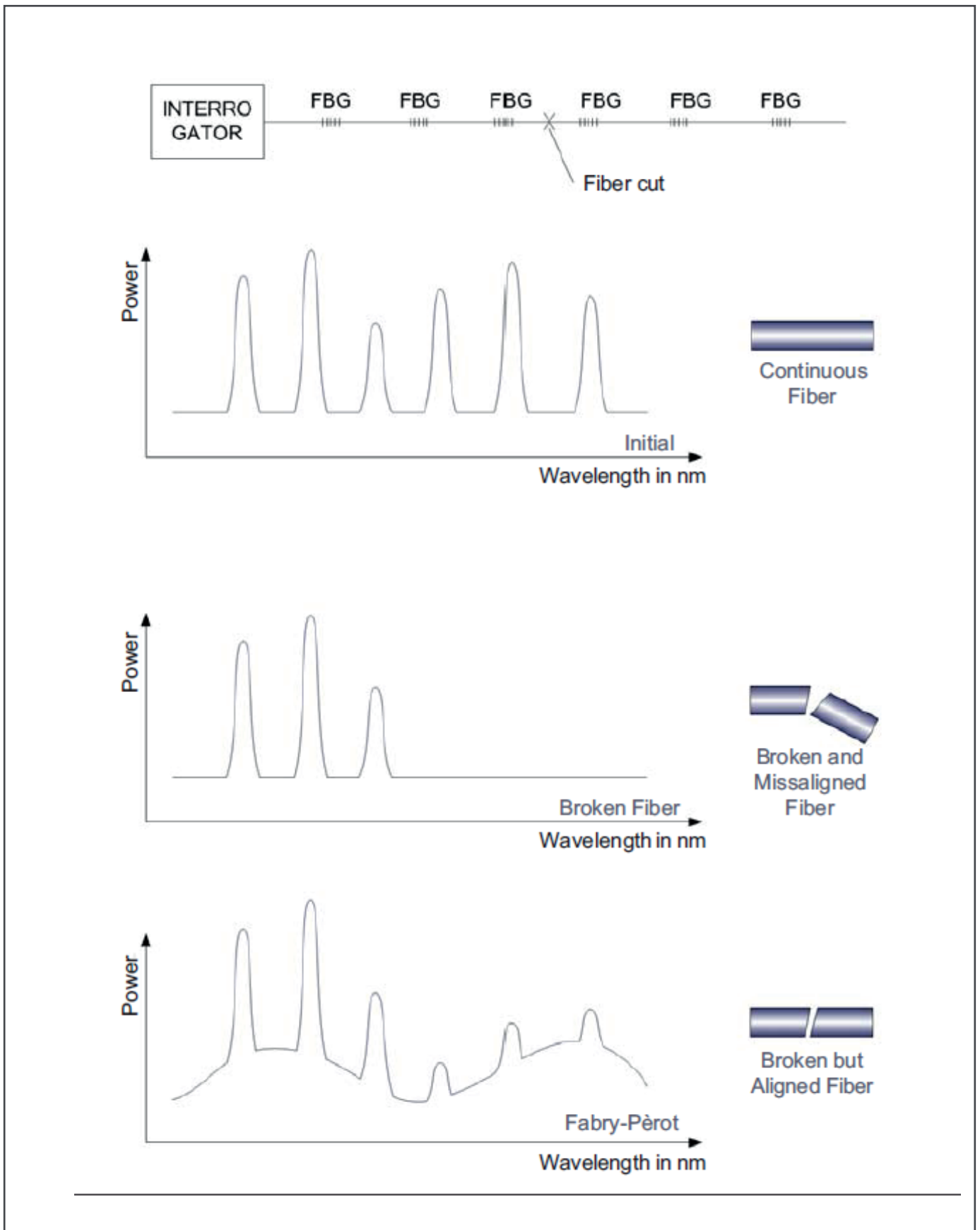

### 3.6.5 Fuse failure

Electrical shorts on the power supply may cause problems to the Interrogator. The DMS Interrogator is directly connected to the 100-240 V power line meaning that it has no external protection. Replaceable fuses are available on the Interrogator's backside next to the power connector (number 5 in fig. 3.1). To replace the fuses, release the top and bottom springs of the fuses' support (Fig. 3.17) and then remove the piece (Fig. 3.18).

Fuse characteristics:

- Rated voltage: 250 Volt AC
- Interrupting rate: 2 Ampere
- Number of fuses: 2

Figure 3.17



Figure 3.18



**For technical support, please call +44 (0)141 488 3664  
or email [support@synapt.ec](mailto:support@synapt.ec)**

Synaptec Ltd, 368 Alexandra Parade, Glasgow, G31 3AU, United Kingdom  
T: +44 (0)141 448 3664 | [info@synapt.ec](mailto:info@synapt.ec) | [synapt.ec](http://synapt.ec)